



## 16-BIT, ULTRA-LOW GLITCH, VOLTAGE OUTPUT DIGITAL-TO-ANALOG CONVERTER

### FEATURES

- **Relative Accuracy: 3LSB**
- **Glitch Energy: 0.1nV-s**
- **MicroPower Operation:**  
140 $\mu$ A at 2.7V
- **Power-On Reset to Zero**
- **Power Supply: +2.7V to +5.5V**
- **16-Bit Monotonic Over Temperature**
- **Settling Time: 10 $\mu$ s to  $\pm$ 0.003% FSR**
- **Low-Power Serial Interface with Schmitt-Triggered Inputs**
- **On-Chip Output Buffer Amplifier with Rail-to-Rail Operation**
- **Power-Down Capability**
- **Binary Input**
- **SYNC Interrupt Facility**
- **Drop-In Compatible With DAC8531/01 and DAC8550 (2's Complement Input)**
- **Available in a Tiny MSOP-8 Package**

### APPLICATIONS

- **Process Control**
- **Data Acquisition Systems**
- **Closed-Loop Servo-Control**
- **PC Peripherals**
- **Portable Instrumentation**
- **Programmable Attenuation**

### DESCRIPTION

The DAC8551 is a small, low-power, voltage output, 16-bit digital-to-analog converter (DAC). It is monotonic, provides good linearity, and minimizes undesired code-to-code transient voltages. The DAC8551 uses a versatile 3-wire serial interface that operates at clock rates to 30MHz and is compatible with standard SPI™, QSPI™, Microwire™, and digital signal processor (DSP) interfaces.

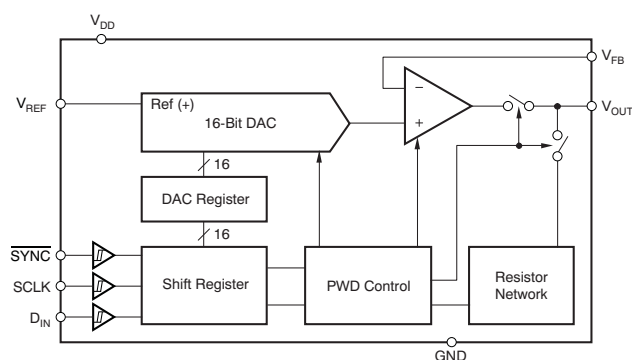
The DAC8551 requires an external reference voltage to set its output range. The DAC8551 incorporates a power-on-reset circuit that ensures the DAC output powers up at 0V and remains there until a valid write takes place to the device. The DAC8551 contains a power-down feature, accessed over the serial interface, that reduces the current consumption of the device to 200nA at 5V.

The low-power consumption of this device in normal operation makes it ideally suited for portable, battery-operated equipment. The power consumption is 0.38mW at 2.7V, reducing to less than 1 $\mu$ W in power-down mode.

The DAC8551 is available in an MSOP-8 package.

For additional flexibility, see the DAC8550, a 2's complement-input counterpart to the DAC8551.

### FUNCTIONAL BLOCK DIAGRAM



Please be aware that an important notice concerning availability, standard warranty, and use in critical applications of Texas Instruments semiconductor products and disclaimers thereto appears at the end of this data sheet.

SPI, QSPI are trademarks of Motorola, Inc.

Microwire is a trademark of National Semiconductor.

All other trademarks are the property of their respective owners.



This integrated circuit can be damaged by ESD. Texas Instruments recommends that all integrated circuits be handled with appropriate precautions. Failure to observe proper handling and installation procedures can cause damage.

ESD damage can range from subtle performance degradation to complete device failure. Precision integrated circuits may be more susceptible to damage because very small parametric changes could cause the device not to meet its published specifications.

**PACKAGING/ORDERING INFORMATION<sup>(1)</sup>**

PRODUCT	MAXIMUM RELATIVE ACCURACY (LSB)	MAXIMUM DIFFERENTIAL NONLINEARITY (LSB)	MAXIMUM GAIN ERROR (% OF FSR)	PACKAGE LEAD	PACKAGE DESIGNATOR	SPECIFIED TEMPERATURE RANGE	PACKAGE MARKING	ORDERING NUMBER	TRANSPORT MEDIA, QUANTITY
DAC8551	±8	±1	±0.15	MSOP-8	DGK	-40°C to +105°C	D81	DAC8551DGK	Tube, 80
								DAC8551DGKT	Tape and Reel, 250
								DAC8551DGKR	Tape and Reel, 2500
DAC8551A	±12	±1	±0.2	MSOP-8	DGK	-40°C to +105°C	D81	DAC8551ADGK	Tube, 80
								DAC8551ADGKT	Tape and Reel, 250
								DAC8551ADGKR	Tape and Reel, 2500

(1) For the most current package and ordering information, see the Package Option Addendum at the end of this data sheet, or see the TI website at [www.ti.com](http://www.ti.com).

**ABSOLUTE MAXIMUM RATINGS<sup>(1)</sup>**

	UNIT	
V <sub>DD</sub> to GND	-0.3V to 6V	
Digital input voltage to GND	-0.3V to +V <sub>DD</sub> + 0.3V	
V <sub>OUT</sub> to GND	-0.3V to +V <sub>DD</sub> + 0.3V	
Operating temperature range	-40°C to +105°C	
Storage temperature range	-65°C to +150°C	
Junction temperature range (T <sub>J</sub> max)	+150°C	
Power dissipation (DGK)	(T <sub>J</sub> max - T <sub>A</sub> )/θ <sub>JA</sub>	
Thermal impedance	θ <sub>JA</sub>	206°C/W
	θ <sub>JC</sub>	44°C/W

(1) Stresses above those listed under *absolute maximum ratings* may cause permanent damage to the device. Exposure to absolute maximum conditions for extended periods may affect device reliability.

**ELECTRICAL CHARACTERISTICS**

V<sub>DD</sub> = 2.7V to 5.5V, and -40°C to +105°C range, unless otherwise noted.

PARAMETER	TEST CONDITIONS	MIN	TYP	MAX	UNIT
<b>STATIC PERFORMANCE<sup>(1)</sup></b>					
Resolution		16			Bits
Relative accuracy	Measured by line passing through codes 485 and 64741	DAC8551	±3	±8	LSB
		DAC8551A	±3	±12	LSB
Differential nonlinearity	16-bit monotonic		±0.25	±1	LSB
Zero-code error	Measured by line passing through codes 485 and 64741		±2	±12	mV
Full-scale error			±0.05	±0.5	% of FSR
Gain error	Measured by line passing through codes 485 and 64741	DAC8551	±0.02	±0.15	% of FSR
		DAC8551A	±0.02	±0.2	% of FSR
Zero-code error drift			±5		µV/°C
Gain temperature coefficient			±1		ppm of FSR/°C
PSRR Power-supply rejection ratio	R <sub>L</sub> = 2kΩ, C <sub>L</sub> = 200pF		0.75		mV/V

(1) Linearity calculated using a reduced code range of 485 to 64741; output unloaded.

**ELECTRICAL CHARACTERISTICS (continued)**

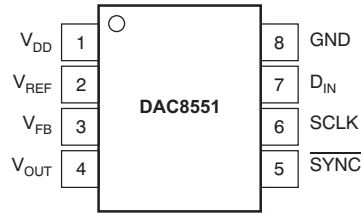
$V_{DD} = 2.7V$  to  $5.5V$ , and  $-40^{\circ}C$  to  $+105^{\circ}C$  range, unless otherwise noted.

PARAMETER	TEST CONDITIONS	MIN	TYP	MAX	UNIT
<b>OUTPUT CHARACTERISTICS (2)</b>					
Output voltage range		0		$V_{REF}$	V
Output voltage settling time	To $\pm 0.003\%$ FSR, 0200h to FD00h, $R_L = 2k\Omega$ , 0pF < $C_L$ < 200pF		8	10	$\mu s$
	$R_L = 2k\Omega$ , $C_L = 50$ pF		12		$\mu s$
Slew rate			1.8		V/ $\mu s$
Capacitive load stability	$R_L = \infty$		470		pF
	$R_L = 2k\Omega$		1000		pF
Code change glitch impulse	1LSB change around major carry		0.1		nV-s
Digital feedthrough	50k $\Omega$ series resistance on digital lines		0.1		
DC output impedance	At mid-code input		1		$\Omega$
Short-circuit current	$V_{DD} = 5V$		50		mA
	$V_{DD} = 3V$		20		
Power-up time	Coming out of power-down mode, $V_{DD} = 5V$		2.5		$\mu s$
	Coming out of power-down mode, $V_{DD} = 3V$		5		
<b>AC PERFORMANCE</b>					
SNR	BW = 20kHz, $V_{DD} = 5V$ , $f_{OUT} = 1kHz$ , 1st 19 harmonics removed for SNR calculation		95		dB
THD			-85		
SFDR			87		
SINAD			84		
<b>REFERENCE INPUT</b>					
Reference current	$V_{REF} = V_{DD} = 5V$		40	75	$\mu A$
	$V_{REF} = V_{DD} = 3.6V$		30	45	$\mu A$
Reference input range		0		$V_{DD}$	V
Reference input impedance			125		k $\Omega$
<b>LOGIC INPUTS (2)</b>					
Input current			$\pm 1$		$\mu A$
$V_{INL}$ Input LOW voltage	$V_{DD} = 5V$			0.8	V
	$V_{DD} = 3V$			0.6	
$V_{INH}$ Input HIGH voltage	$V_{DD} = 5V$	2.4			V
	$V_{DD} = 3V$	2.1			
Pin capacitance				3	pF
<b>POWER REQUIREMENTS</b>					
$V_{DD}$		2.7		5.5	V
$I_{DD}$ (normal mode)	Input code = 32768, no load, does not include reference current				
$V_{DD} = 3.6V$ to $5.5V$	$V_{IH} = V_{DD}$ and $V_{IL} = GND$		160	250	$\mu A$
		$V_{DD} = 2.7V$ to $3.6V$	140	240	
$I_{DD}$ (all power-down modes)	$V_{IH} = V_{DD}$ and $V_{IL} = GND$		0.2	2	$\mu A$
		$V_{DD} = 2.7V$ to $3.6V$	0.05	2	
<b>POWER EFFICIENCY</b>					
$I_{OUT}/I_{DD}$	$I_{LOAD} = 2mA$ , $V_{DD} = 5V$		89		%
<b>TEMPERATURE RANGE</b>					
Specified performance		-40		+105	$^{\circ}C$

(2) Specified by design and characterization; not production tested.

**PIN CONFIGURATION**

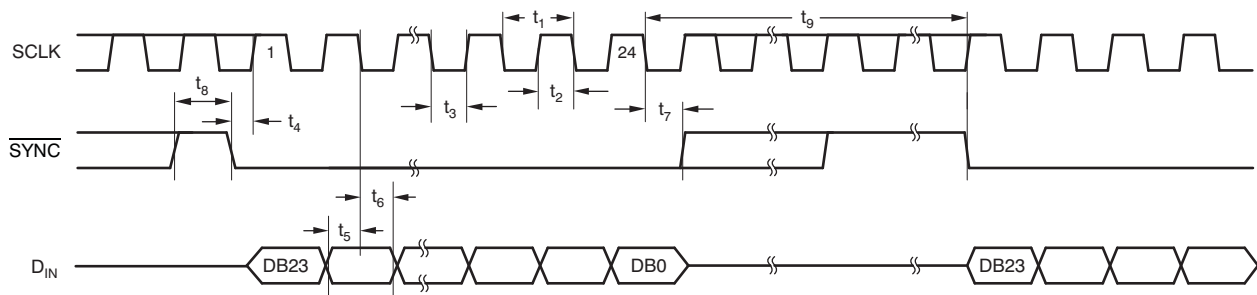
DGK PACKAGE  
MSOP-8  
(Top View)



**PIN DESCRIPTIONS**

PIN	NAME	DESCRIPTION
1	V <sub>DD</sub>	Power supply input, 2.7V to 5.5V.
2	V <sub>REF</sub>	Reference voltage input.
3	V <sub>FB</sub>	Feedback connection for the output amplifier. For voltage output operation, tie to V <sub>OUT</sub> externally.
4	V <sub>OUT</sub>	Analog output voltage from DAC. The output amplifier has rail-to-rail operation.
5	$\overline{\text{SYNC}}$	Level-triggered control input (active LOW). This is the frame synchronization signal for the input data. When $\overline{\text{SYNC}}$ goes LOW, it enables the input shift register and data is transferred in on the falling edges of the following clocks. The DAC is updated following the 24th clock (unless $\overline{\text{SYNC}}$ is taken HIGH before this edge, in which case the rising edge of $\overline{\text{SYNC}}$ acts as an interrupt and the write sequence is ignored by the DAC8551). Schmitt-Trigger logic input.
6	SCLK	Serial clock input. Data can be transferred at rates up to 30MHz. Schmitt-Trigger logic input.
7	D <sub>IN</sub>	Serial data input. Data is clocked into the 24-bit input shift register on each falling edge of the serial clock input. Schmitt-Trigger logic input.
8	GND	Ground reference point for all circuitry on the part.

## SERIAL WRITE OPERATION



## TIMING CHARACTERISTICS<sup>(1)(2)</sup>

$V_{DD} = 2.7V$  to  $5.5V$ , all specifications  $-40^{\circ}C$  to  $+105^{\circ}C$  (unless otherwise noted).

PARAMETER	TEST CONDITIONS	MIN	TYP	MAX	UNIT
$t_1^{(3)}$ SCLK cycle time	$V_{DD} = 2.7V$ to $3.6V$	50			ns
	$V_{DD} = 3.6V$ to $5.5V$	33			
$t_2$ SCLK HIGH time	$V_{DD} = 2.7V$ to $3.6V$	13			ns
	$V_{DD} = 3.6V$ to $5.5V$	13			
$t_3$ SCLK LOW time	$V_{DD} = 2.7V$ to $3.6V$	22.5			ns
	$V_{DD} = 3.6V$ to $5.5V$	13			
$t_4$ SYNC to SCLK rising edge setup time	$V_{DD} = 2.7V$ to $3.6V$	0			ns
	$V_{DD} = 3.6V$ to $5.5V$	0			
$t_5$ Data setup time	$V_{DD} = 2.7V$ to $3.6V$	5			ns
	$V_{DD} = 3.6V$ to $5.5V$	5			
$t_6$ Data hold time	$V_{DD} = 2.7V$ to $3.6V$	4.5			ns
	$V_{DD} = 3.6V$ to $5.5V$	4.5			
$t_7$ 24th SCLK falling edge to SYNC rising edge	$V_{DD} = 2.7V$ to $3.6V$	0			ns
	$V_{DD} = 3.6V$ to $5.5V$	0			
$t_8$ Minimum SYNC HIGH time	$V_{DD} = 2.7V$ to $3.6V$	50			ns
	$V_{DD} = 3.6V$ to $5.5V$	33			
$t_9$ 24th SCLK falling edge to SYNC falling edge	$V_{DD} = 2.7V$ to $5.5V$	100			ns

(1) All input signals are specified with  $t_R = t_F = 5ns$  (10% to 90% of  $V_{DD}$ ) and timed from a voltage level of  $(V_{IL} + V_{IH})/2$ .

(2) See [Serial Write Operation Timing Diagram](#).

(3) Maximum SCLK frequency is 30MHz at  $V_{DD} = 3.6V$  to  $5.5V$  and 20MHz at  $V_{DD} = 2.7V$  to  $3.6V$ .

**TYPICAL CHARACTERISTICS:  $V_{DD} = 5\text{ V}$**

At  $T_A = +25^\circ\text{C}$ , unless otherwise noted.

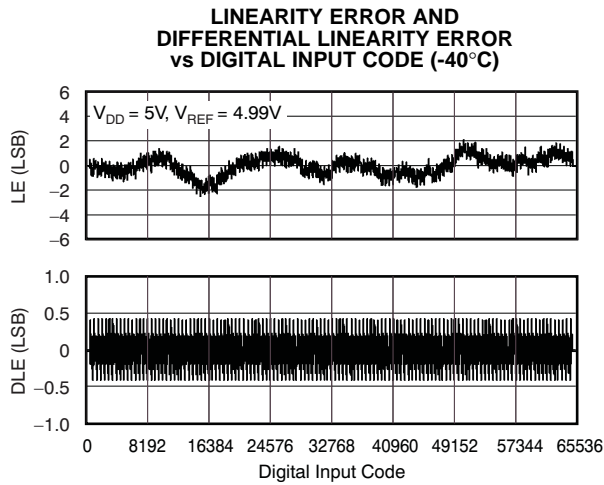


Figure 1.

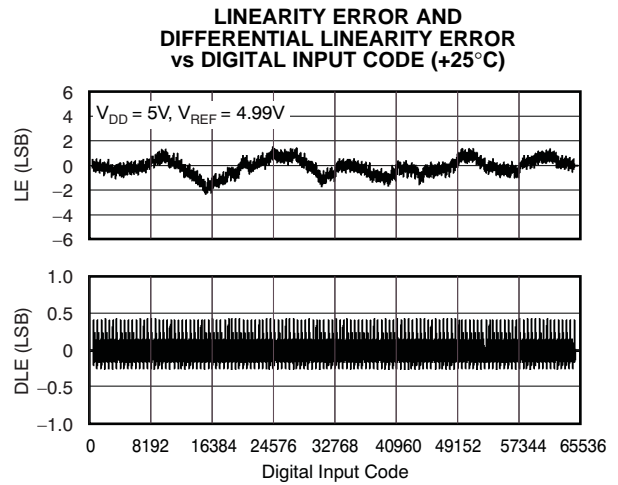


Figure 2.

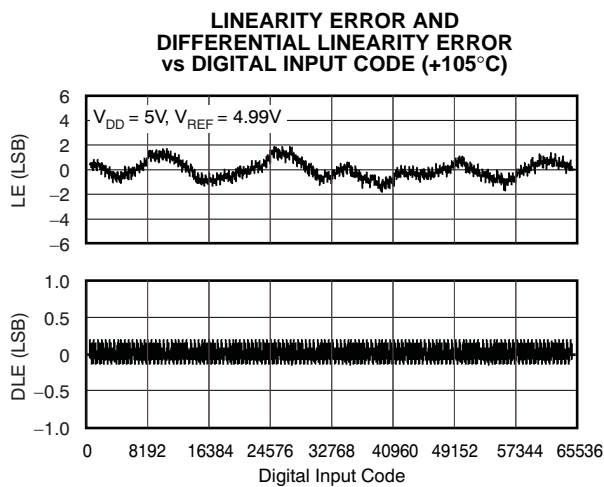


Figure 3.

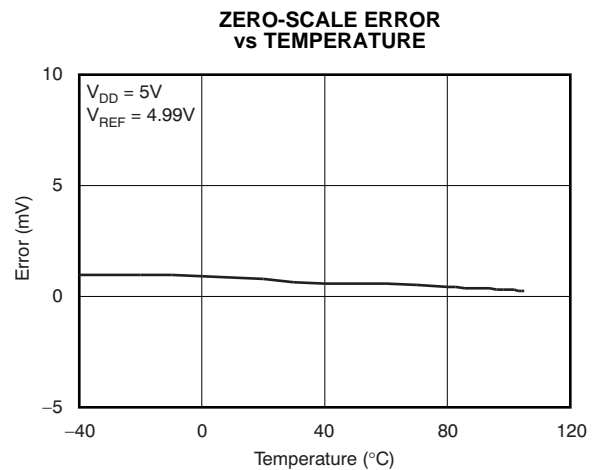


Figure 4.

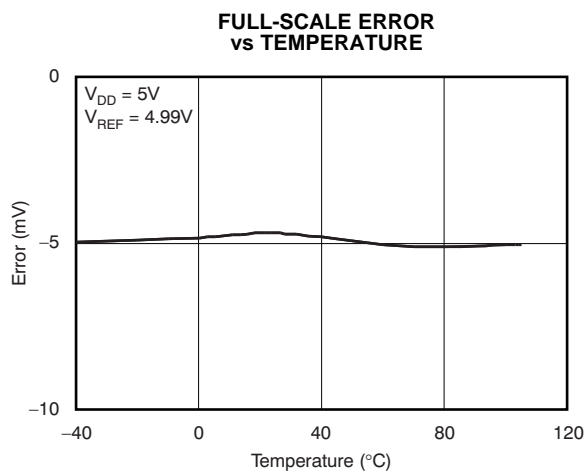


Figure 5.

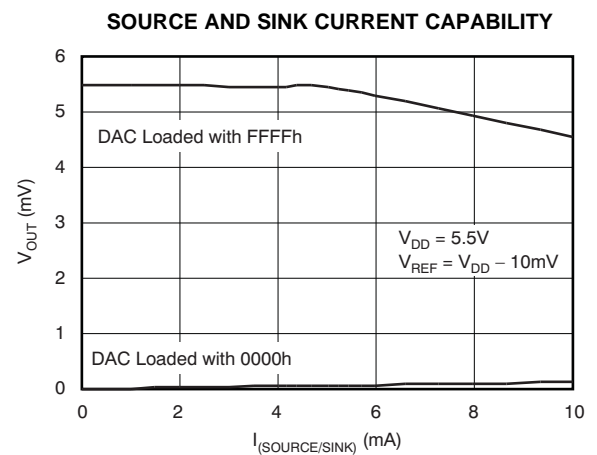


Figure 6.

**TYPICAL CHARACTERISTICS:  $V_{DD} = 5\text{ V}$  (continued)**

At  $T_A = +25^\circ\text{C}$ , unless otherwise noted.

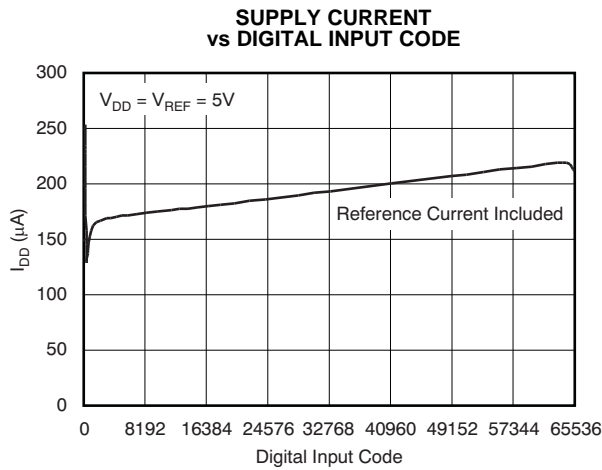


Figure 7.

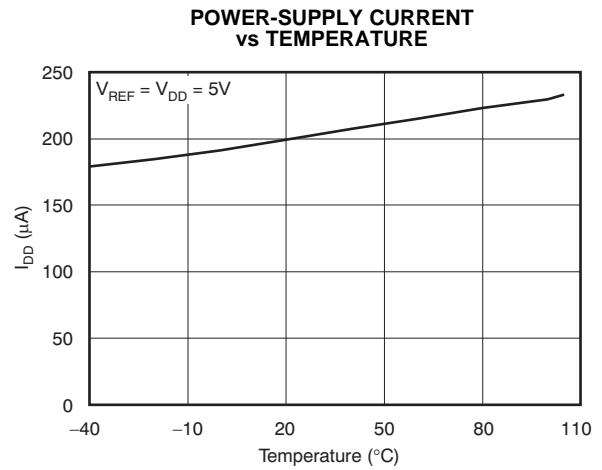


Figure 8.

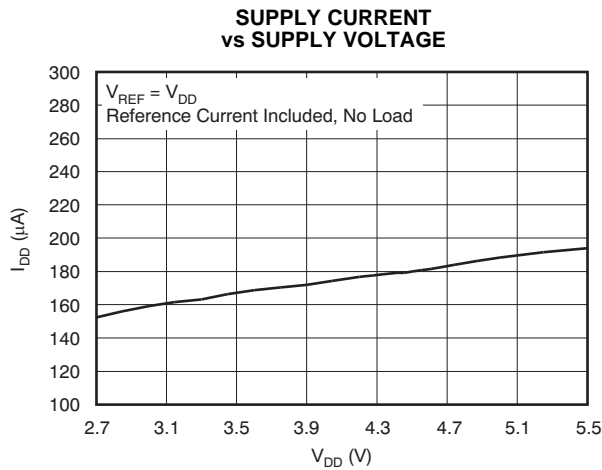


Figure 9.

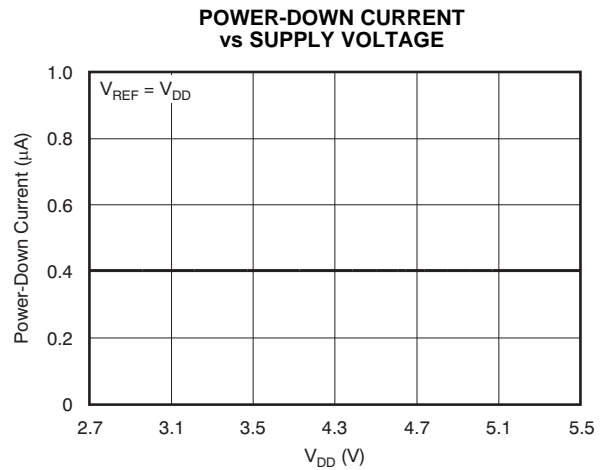


Figure 10.

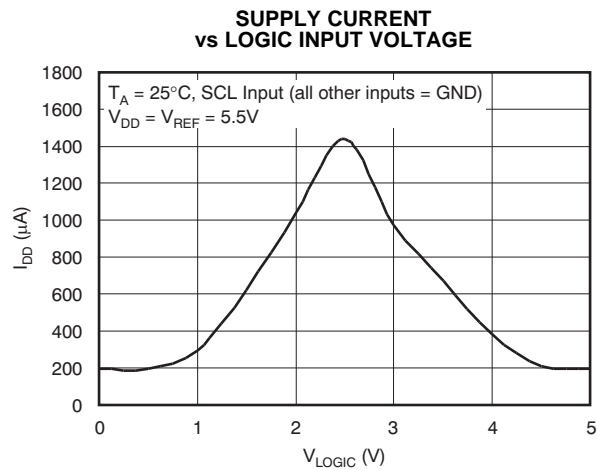


Figure 11.

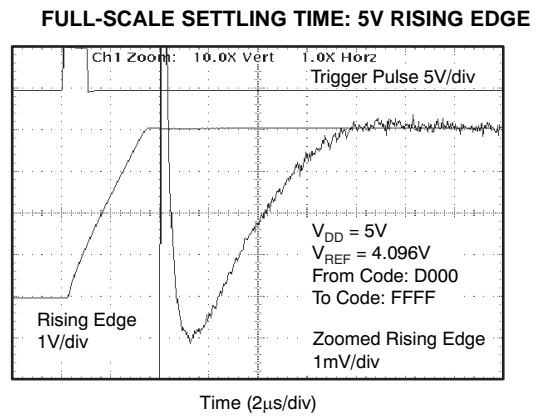
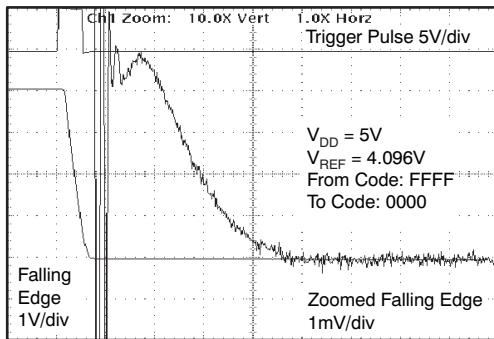


Figure 12.

**TYPICAL CHARACTERISTICS:  $V_{DD} = 5\text{ V}$  (continued)**

At  $T_A = +25^\circ\text{C}$ , unless otherwise noted.

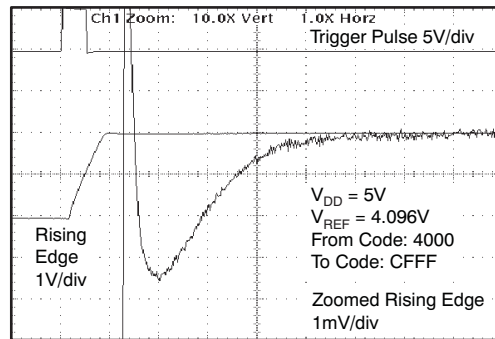
**FULL-SCALE SETTLING TIME: 5V FALLING EDGE**



Time (2µs/div)

**Figure 13.**

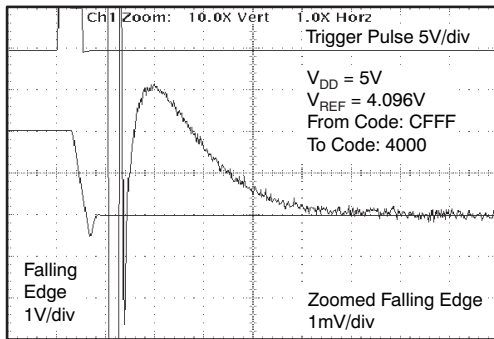
**HALF-SCALE SETTLING TIME: 5V RISING EDGE**



Time (2µs/div)

**Figure 14.**

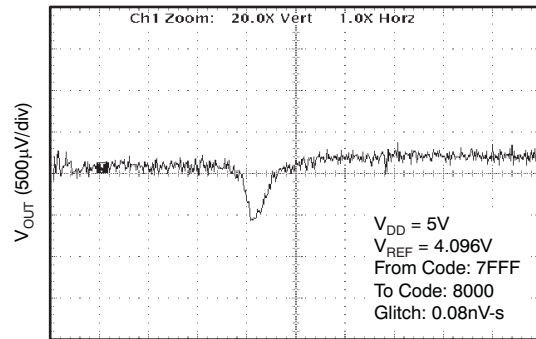
**HALF-SCALE SETTLING TIME: 5V FALLING EDGE**



Time (2µs/div)

**Figure 15.**

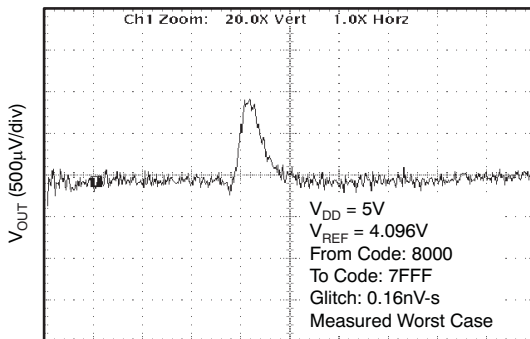
**GLITCH ENERGY: 5V, 1LSB STEP, RISING EDGE**



Time (400ns/div)

**Figure 16.**

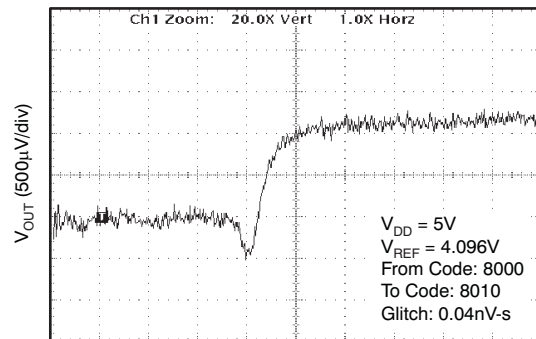
**GLITCH ENERGY: 5V, 1LSB STEP, FALLING EDGE**



Time (400ns/div)

**Figure 17.**

**GLITCH ENERGY: 5V, 16LSB STEP, RISING EDGE**



Time (400ns/div)

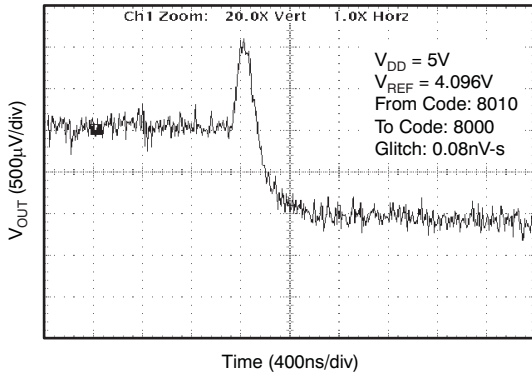
**Figure 18.**



**TYPICAL CHARACTERISTICS:  $V_{DD} = 5\text{ V}$  (continued)**

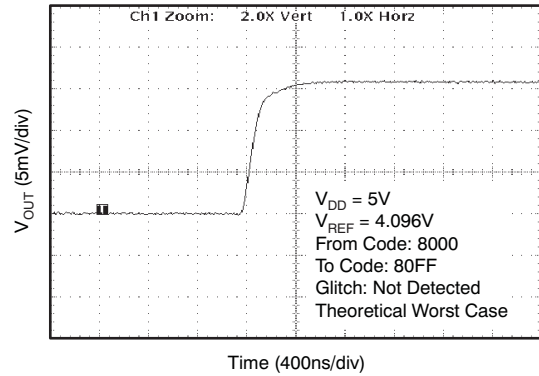
At  $T_A = +25^\circ\text{C}$ , unless otherwise noted.

**GLITCH ENERGY: 5V, 16LSB STEP, FALLING EDGE**



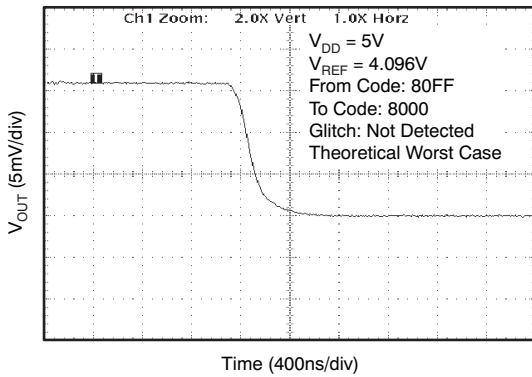
**Figure 19.**

**GLITCH ENERGY: 5V, 256LSB STEP, RISING EDGE**



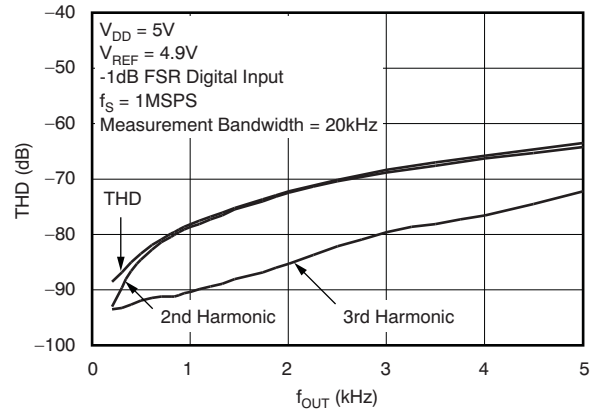
**Figure 20.**

**GLITCH ENERGY: 5V, 256LSB STEP, FALLING EDGE**



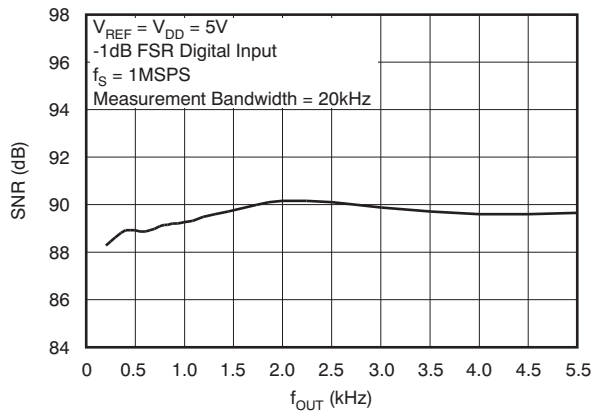
**Figure 21.**

**TOTAL HARMONIC DISTORTION vs OUTPUT FREQUENCY**



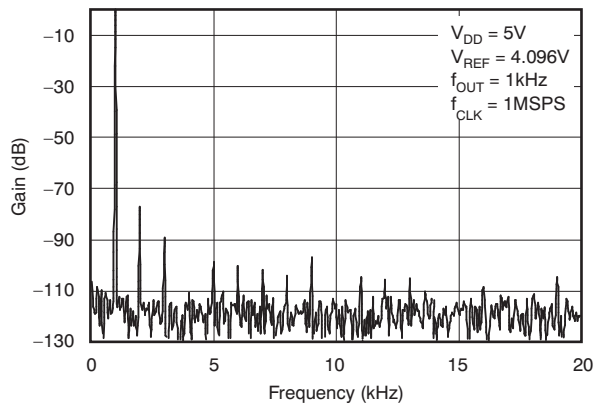
**Figure 22.**

**SIGNAL-TO-NOISE RATIO vs OUTPUT FREQUENCY**

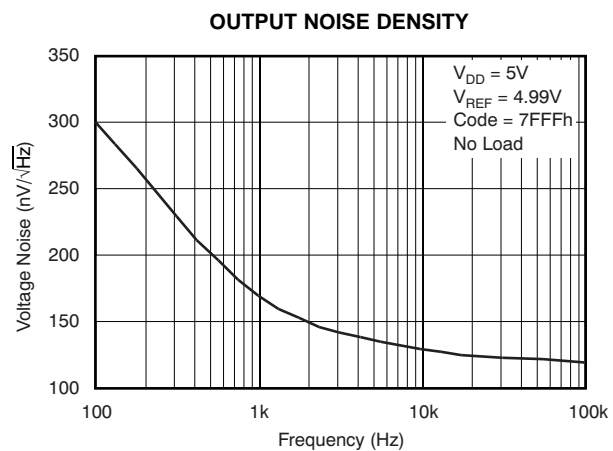


**Figure 23.**

**POWER SPECTRAL DENSITY**



**Figure 24.**

**TYPICAL CHARACTERISTICS:  $V_{DD} = 5\text{ V}$  (continued)**At  $T_A = +25^\circ\text{C}$ , unless otherwise noted.

**TYPICAL CHARACTERISTICS:  $V_{DD} = 2.7\text{ V}$**

At  $T_A = +25^\circ\text{C}$ , unless otherwise noted.

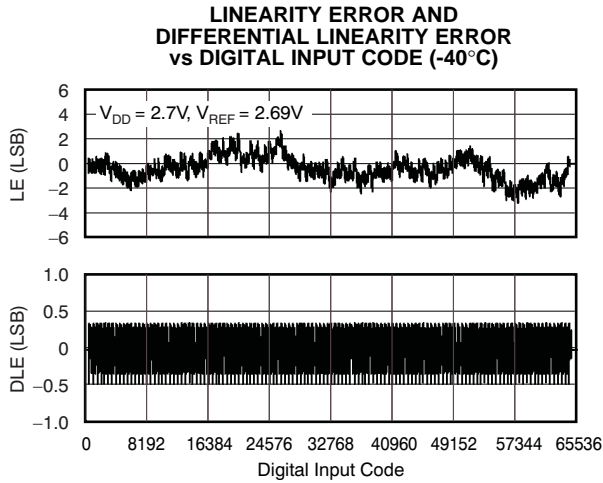


Figure 26.

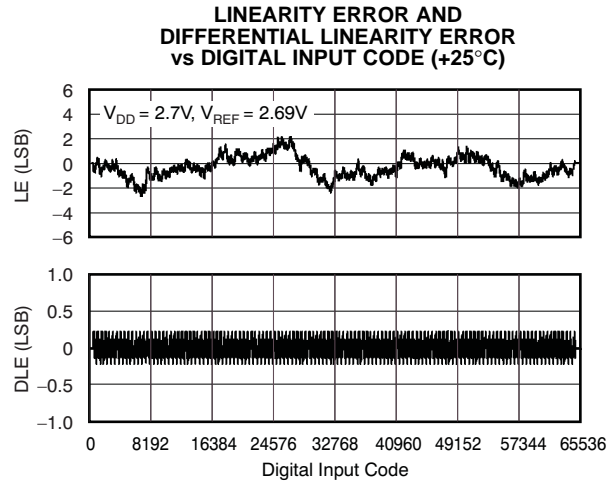


Figure 27.

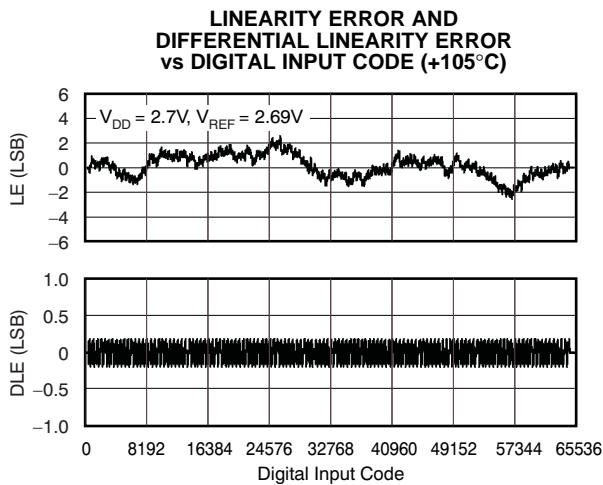


Figure 28.

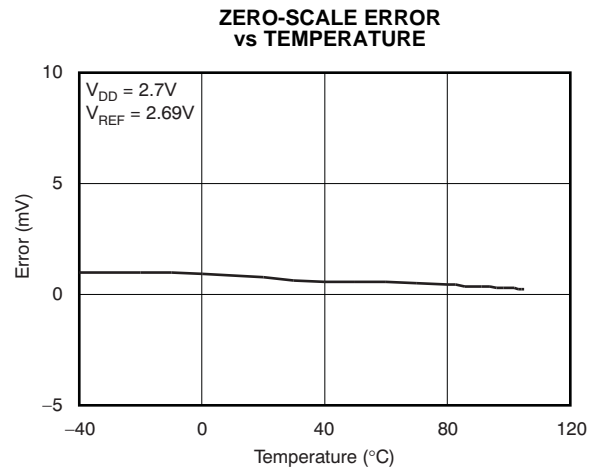


Figure 29.

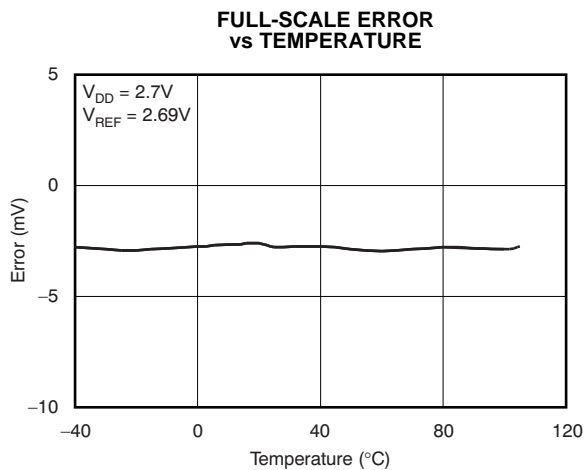


Figure 30.

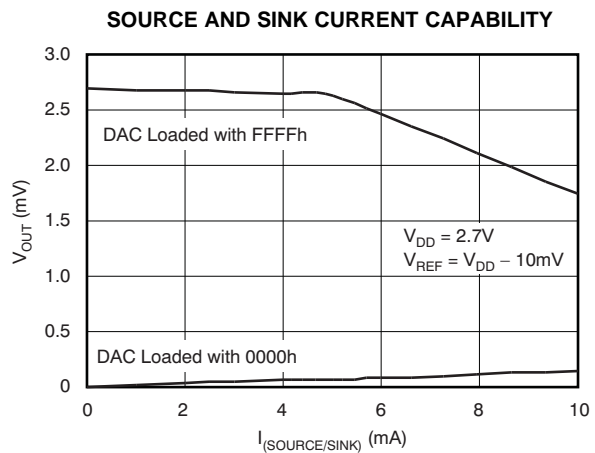


Figure 31.

**TYPICAL CHARACTERISTICS:  $V_{DD} = 2.7\text{ V}$  (continued)**

At  $T_A = +25^\circ\text{C}$ , unless otherwise noted.

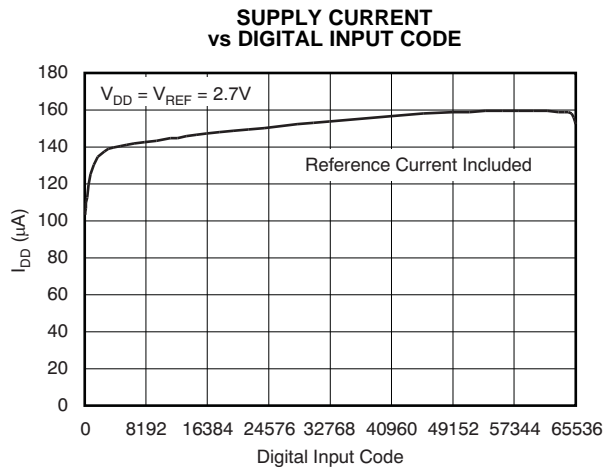


Figure 32.

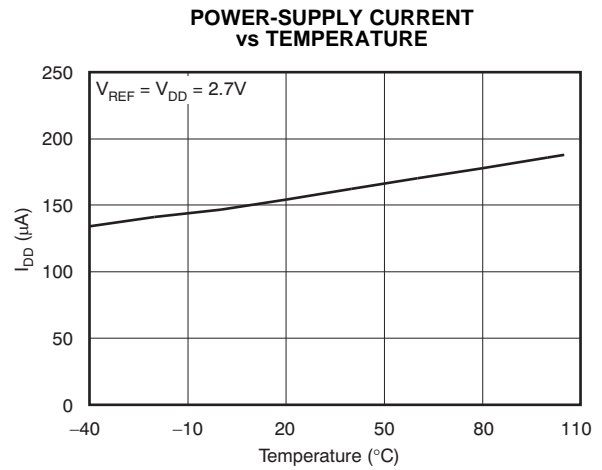


Figure 33.

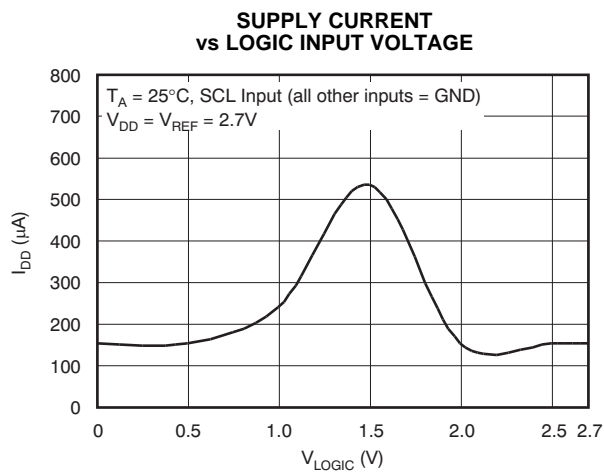


Figure 34.

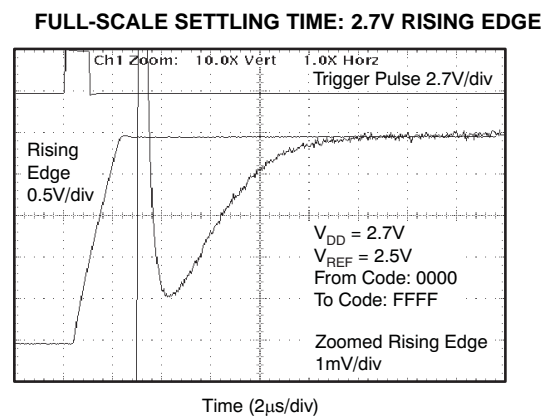


Figure 35.

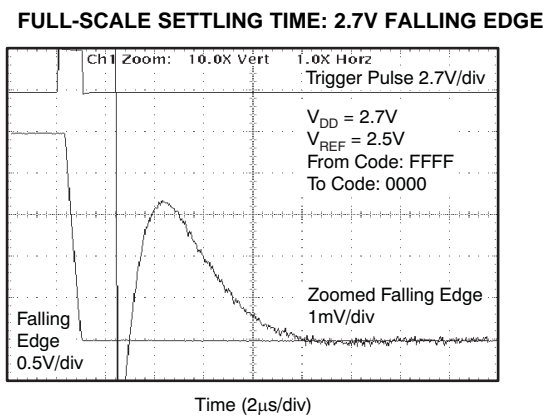


Figure 36.

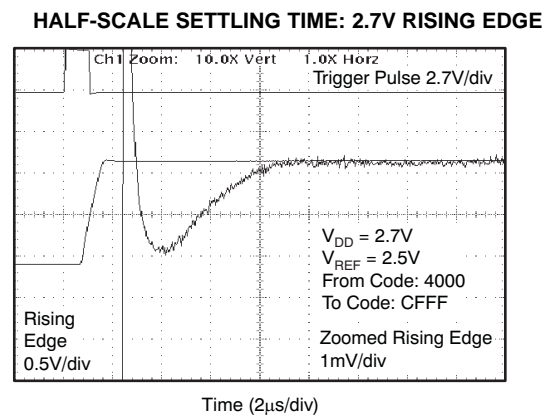
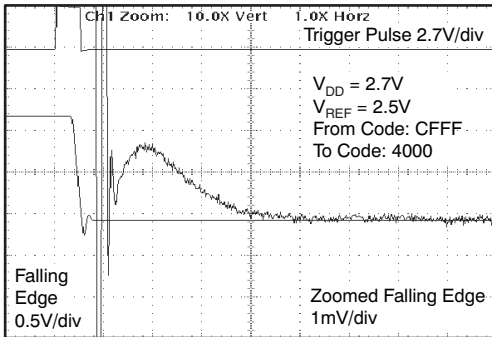


Figure 37.

**TYPICAL CHARACTERISTICS:  $V_{DD} = 2.7\text{ V}$  (continued)**

At  $T_A = +25^\circ\text{C}$ , unless otherwise noted.

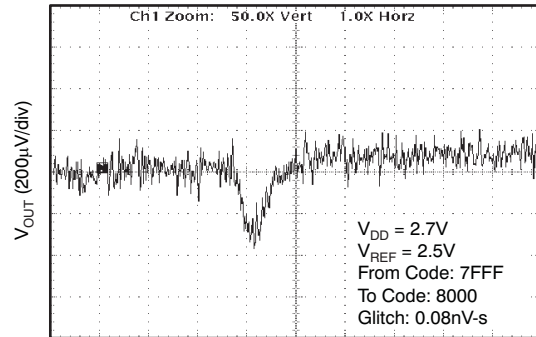
**HALF-SCALE SETTLING TIME: 2.7V FALLING EDGE**



Time (2µs/div)

**Figure 38.**

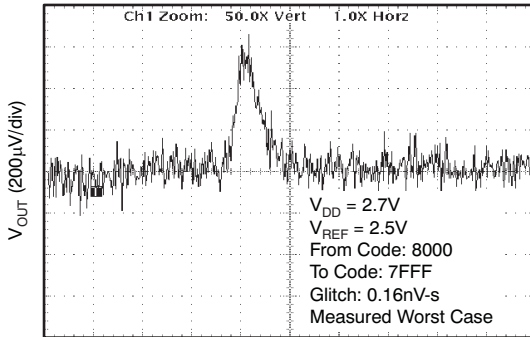
**GLITCH ENERGY: 2.7V, 1LSB STEP, RISING EDGE**



Time (400ns/div)

**Figure 39.**

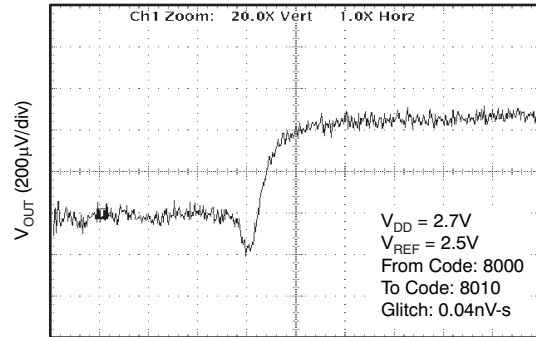
**GLITCH ENERGY: 2.7V, 1LSB STEP, FALLING EDGE**



Time (400ns/div)

**Figure 40.**

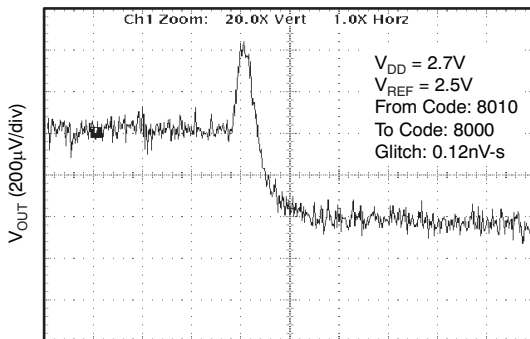
**GLITCH ENERGY: 2.7V, 16LSB STEP, RISING EDGE**



Time (400ns/div)

**Figure 41.**

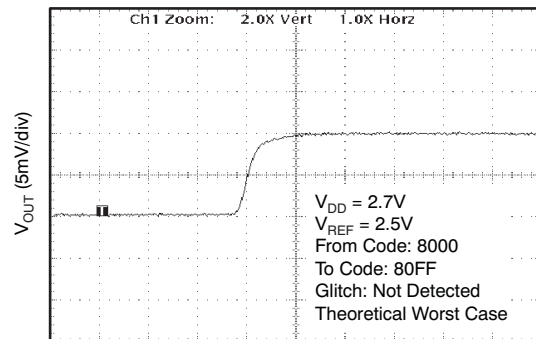
**GLITCH ENERGY: 2.7V, 16LSB STEP, FALLING EDGE**



Time (400ns/div)

**Figure 42.**

**GLITCH ENERGY: 2.7V, 256LSB STEP, RISING EDGE**



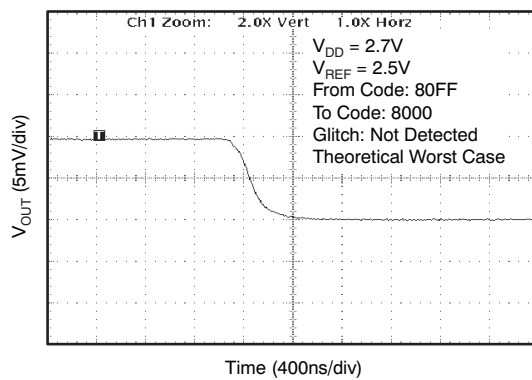
Time (400ns/div)

**Figure 43.**

**TYPICAL CHARACTERISTICS:  $V_{DD} = 2.7\text{ V}$  (continued)**

At  $T_A = +25^\circ\text{C}$ , unless otherwise noted.

**GLITCH ENERGY: 2.7V, 256LSB STEP, FALLING EDGE**



**Figure 44.**

## THEORY OF OPERATION

### DAC SECTION

The DAC8551 architecture consists of a string DAC followed by an output buffer amplifier. Figure 45 shows a block diagram of the DAC architecture.

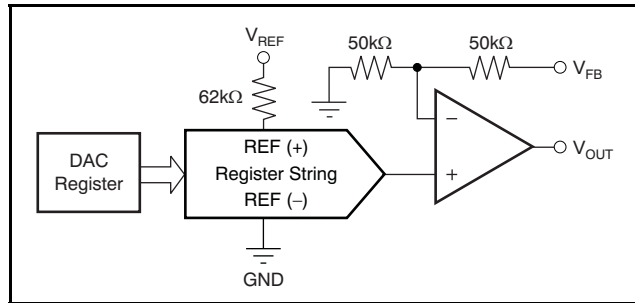


Figure 45. DAC8551 Architecture

The input coding to the DAC8551 is straight binary, so the ideal output voltage is given by:

$$V_{OUT} = \frac{D_{IN}}{65536} \times V_{REF} \quad (1)$$

where  $D_{IN}$  = decimal equivalent of the binary code that is loaded to the DAC register; it can range from 0 to 65535.

### RESISTOR STRING

The resistor string section is shown in Figure 46. It is simply a string of resistors, each of value  $R$ . The code loaded into the DAC register determines at which node on the string the voltage is tapped off to be fed into the output amplifier by closing one of the switches connecting the string to the amplifier. Monotonicity is ensured because of the string resistor architecture.

### OUTPUT AMPLIFIER

The output buffer amplifier is capable of generating rail-to-rail voltages on its output, giving an output range of 0V to  $V_{DD}$ . It is capable of driving a load of  $2k\Omega$  in parallel with  $1000pF$  to GND. The source and sink capabilities of the output amplifier can be seen in the Typical Characteristics. The slew rate is  $1.8V/\mu s$  with a full-scale setting time of  $8\mu s$  with the output unloaded.

The inverting input of the output amplifier is brought out to the  $V_{FB}$  pin. This configuration allows for better accuracy in critical applications by tying the  $V_{FB}$  point and the amplifier output together directly at the load. Other signal conditioning circuitry may also be connected between these points for specific applications.

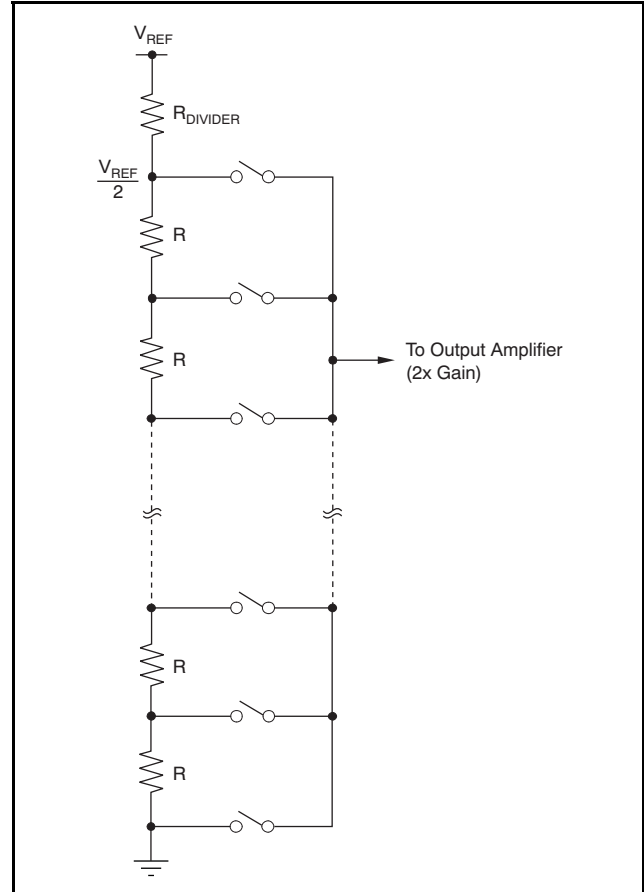


Figure 46. Resistor String

### SERIAL INTERFACE

The DAC8551 has a 3-wire serial interface ( $\overline{SYNC}$ , SCLK, and  $D_{IN}$ ), which is compatible with SPI, QSPI, and Microwire interface standards, as well as most DSPs. See the Serial Write Operation Timing Diagram for an example of a typical write sequence.

The write sequence begins by bringing the  $\overline{SYNC}$  line LOW. Data from the  $D_{IN}$  line are clocked into the 24-bit shift register on each falling edge of SCLK. The serial clock frequency can be as high as 30MHz, making the DAC8551 compatible with high-speed DSPs. On the 24th falling edge of the serial clock, the last data bit is clocked in and the programmed function is executed (that is, a change in DAC register contents and/or a change in the mode of operation).

At this point, the  $\overline{\text{SYNC}}$  line may be kept LOW or brought HIGH. In either case, it must be brought HIGH for a minimum of 33ns before the next write sequence so that a falling edge of  $\overline{\text{SYNC}}$  can initiate the next write sequence. As previously mentioned, it must be brought HIGH again just before the next write sequence.

### INPUT SHIFT REGISTER

The input shift register is 24 bits wide, as shown in Figure 47. The first six bits are *don't care* bits. The next two bits (PD1 and PD0) are control bits that control which mode of operation the part is in (normal mode or any one of three power-down modes). A more complete description of the various modes is located in the Power-Down Modes section. The next 16 bits are the data bits. These bits are transferred to the DAC register on the 24th falling edge of SCLK.

### $\overline{\text{SYNC}}$ INTERRUPT

In a normal write sequence, the  $\overline{\text{SYNC}}$  line is kept LOW for at least 24 falling edges of SCLK and the DAC is updated on the 24th falling edge. However, if  $\overline{\text{SYNC}}$  is brought HIGH before the 24th falling edge, it acts as an interrupt to the write sequence. The shift register is reset, and the write sequence is seen as invalid. Neither an update of the DAC register contents nor a change in the operating mode occurs, as shown in Figure 48.

### POWER-ON RESET

The DAC8551 contains a power-on-reset circuit that controls the output voltage during power up. On power up, the DAC registers are filled with zeros and the output voltages are 0V; they remain that way until a valid write sequence is made to the DAC. The power-on reset is useful in applications where it is important to know the state of the output of the DAC while it is in the process of powering up.

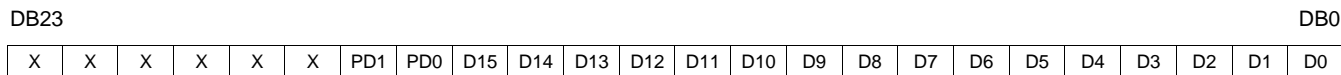


Figure 47. DAC8551 Data Input Register Format

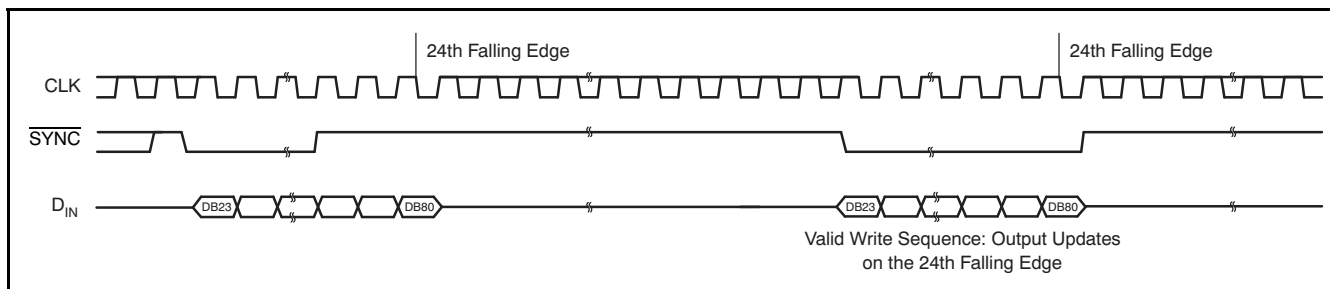


Figure 48.  $\overline{\text{SYNC}}$  Interrupt Facility



## POWER-DOWN MODES

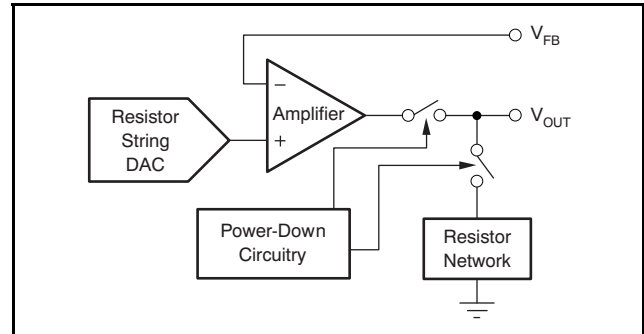
The DAC8551 supports four separate modes of operation. These modes are programmable by setting two bits (PD1 and PD0) in the control register. Table 1 shows how the state of the bits corresponds to the mode of operation of the device.

**Table 1. Operating Modes**

PD1 (DB17)	PD0 (DB16)	OPERATING MODE
0	0	Normal operation
–	–	Power-down modes
0	1	Output typically 1kΩ to GND
1	0	Output typically 100kΩ to GND
1	1	High-Z

When both bits are set to '0', the device works normally with its typical current consumption of 200μA at 5V. However, for the three power-down modes, the supply current falls to 200nA at 5V (50nA at 3V). Not only does the supply current fall, but the output stage is also internally switched from the output of the amplifier to a resistor network of known values. This configuration has the advantage that the output impedance of the device is known while it is in

power-down mode. There are three different options. The output is connected internally to GND through a 1kΩ resistor, a 100kΩ resistor, or it is left open-circuited (High-Z). The output stage is illustrated in Figure 49.



**Figure 49. Output Stage During Power-Down**

All analog circuitry is shut down when the power-down mode is activated. However, the contents of the DAC register are unaffected when in power-down. The time to exit power-down is typically 2.5μs for  $V_{DD} = 5V$ , and 5μs for  $V_{DD} = 3V$ . See the [Typical Characteristics](#) for more information.

## MICROPROCESSOR INTERFACING

### DAC8551 to 8051 Interface

See [Figure 50](#) for a serial interface between the DAC8551 and a typical 8051-type microcontroller. The setup for the interface is as follows: TXD of the 8051 drives SCLK of the DAC8551, while RXD drives the serial data line of the device. The  $\overline{\text{SYNC}}$  signal is derived from a bit-programmable pin on the port of the 8051. In this case, port line P3.3 is used. When data are to be transmitted to the DAC8551, P3.3 is taken LOW. The 8051 transmits data in 8-bit bytes; thus, only eight falling clock edges occur in the transmit cycle. To load data to the DAC, P3.3 is left LOW after the first eight bits are transmitted, then a second write cycle is initiated to transmit the second byte of data. P3.3 is taken HIGH following the completion of the third write cycle. The 8051 outputs the serial data in a format that has the LSB first. The DAC8551 requires data with the MSB as the first bit received. The 8051 transmit routine must therefore take this into account, and *mirror* the data as needed.

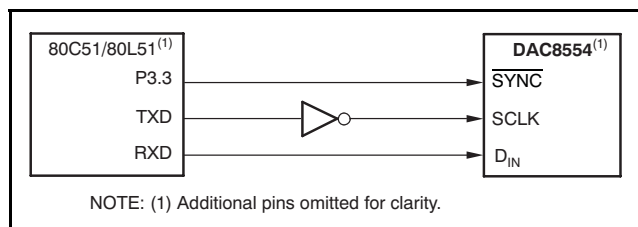


Figure 50. DAC8551 to 80C51/80L51 Interface

### DAC8551 to Microwire Interface

[Figure 51](#) shows an interface between the DAC8551 and any Microwire-compatible device. Serial data are shifted out on the falling edge of the serial clock and is clocked into the DAC8551 on the rising edge of the SK signal.

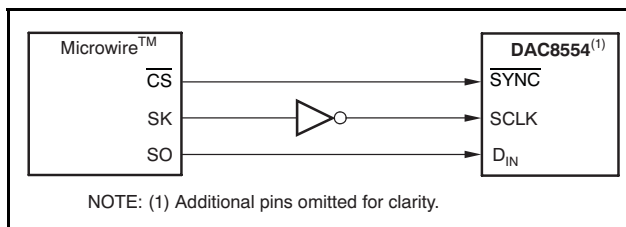


Figure 51. DAC8551 to Microwire Interface

### DAC8551 to 68HC11 Interface

[Figure 52](#) shows a serial interface between the DAC8551 and the 68HC11 microcontroller. SCK of the 68HC11 drives the SCLK of the DAC8551, while the MOSI output drives the serial data line of the DAC. The  $\overline{\text{SYNC}}$  signal is derived from a port line (PC7), similar to the 8051 diagram.

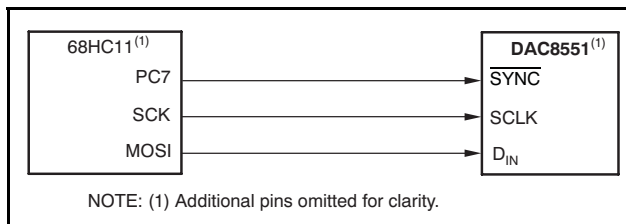


Figure 52. DAC8551 to 68HC11 Interface

The 68HC11 should be configured so that its CPOL bit is '0' and its CPHA bit is '1'. This configuration causes data appearing on the MOSI output to be valid on the falling edge of SCK. When data are being transmitted to the DAC, the  $\overline{\text{SYNC}}$  line is held LOW (PC7). Serial data from the 68HC11 are transmitted in 8-bit bytes with only eight falling clock edges occurring in the transmit cycle. (Data are transmitted MSB first.) In order to load data to the DAC8551, PC7 is left LOW after the first eight bits are transferred, then a second and third serial write operation are performed to the DAC. PC7 is taken HIGH at the end of this procedure.

## APPLICATION INFORMATION

### USING THE REF02 AS A POWER SUPPLY FOR THE DAC8551

Due to the extremely low supply current required by the DAC8551, an alternative option is to use the REF02 (+5 V precision voltage reference) to supply the required voltage to the device, as illustrated in Figure 53.

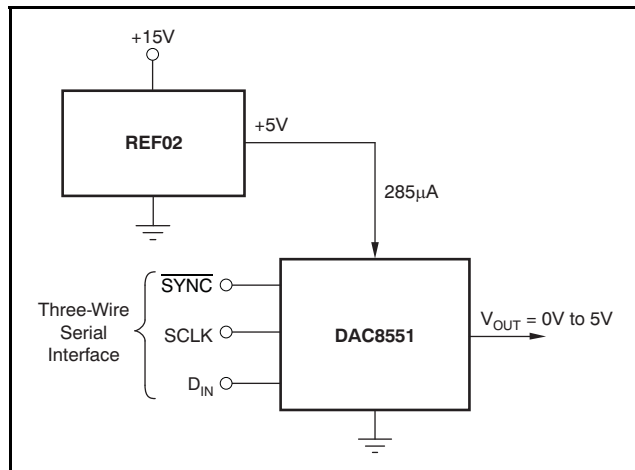


Figure 53. REF02 as a Power Supply to the DAC8551

This configuration is especially useful if the power supply is quite noisy or if the system supply voltages are at some value other than 5V. The REF02 outputs a steady supply voltage for the DAC8551. If the REF02 is used, the current it needs to supply to the DAC8551 is 200µA. This configuration is with no load on the output of the DAC. When a DAC output is loaded, the REF02 also needs to supply the current to the load.

The total typical current required (with a 5kΩ load on the DAC output) is:

$$200\mu\text{A} + \frac{5\text{V}}{5\text{k}\Omega} = 1.2\text{mA} \quad (2)$$

The load regulation of the REF02 is typically 0.005%/mA, resulting in an error of 299µV for the 1.2mA current drawn from it. This value corresponds to a 3.9LSB error.

### BIPOLAR OPERATION USING THE DAC8551

The DAC8551 has been designed for single-supply operation, but a bipolar output range is also possible using the circuit in Figure 54. The circuit shown gives an output voltage range of  $\pm V_{\text{REF}}$ . Rail-to-rail operation at the amplifier output is achievable using an OPA703 as the output amplifier.

The output voltage for any input code can be calculated as follows:

$$V_o = \left[ V_{\text{REF}} \times \left( \frac{D}{65536} \right) \times \left( \frac{R_1 + R_2}{R_1} \right) - V_{\text{REF}} \times \left( \frac{R_2}{R_1} \right) \right] \quad (3)$$

where D represents the input code in decimal (0–65535).

With  $V_{\text{REF}} = 5\text{V}$ ,  $R_1 = R_2 = 10\text{k}\Omega$ .

$$V_o = \left( \frac{10 \times D}{65536} \right) - 5\text{V} \quad (4)$$

Using this example, an output voltage range of  $\pm 5\text{V}$  with 0000h corresponding to a  $-5\text{V}$  output and FFFFh corresponding to a  $5\text{V}$  output can be achieved. Similarly, using  $V_{\text{REF}} = 2.5\text{V}$ , a  $\pm 2.5\text{V}$  output voltage range can be achieved.

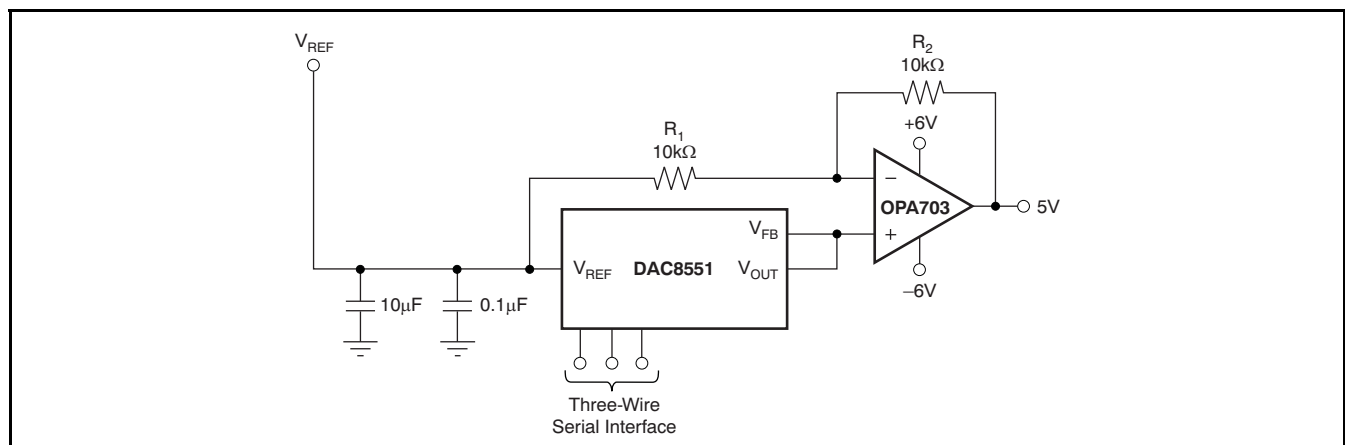


Figure 54. Bipolar Output Range

## LAYOUT

A precision analog component requires careful layout, adequate bypassing, and clean, well-regulated power supplies.

The DAC8551 offers single-supply operation, and it often is used in close proximity with digital logic, microcontrollers, microprocessors, and digital signal processors. The more digital logic present in the design and the higher the switching speed, the more difficult it is to keep digital noise from appearing at the output.

Due to the single ground pin of the DAC8551, all return currents, including digital and analog return currents for the DAC, must flow through a single point. Ideally, GND would be connected directly to an analog ground plane. This plane would be separate from the ground connection for the digital components until they were connected at the power-entry point of the system.

The power applied to  $V_{DD}$  should be well-regulated and low-noise. Switching power supplies and dc/dc converters often have high-frequency glitches or spikes riding on the output voltage. In addition, digital components can create similar high-frequency spikes. This noise can easily couple into the DAC output voltage through various paths between the power connections and analog output.

As with the GND connection,  $V_{DD}$  should be connected to a 5V power-supply plane or trace that is separate from the connection for digital logic until they are connected at the power-entry point. In addition, a 1 $\mu$ F to 10 $\mu$ F capacitor and 0.1 $\mu$ F bypass capacitor are strongly recommended. In some situations, additional bypassing may be required, such as a 100 $\mu$ F electrolytic capacitor or even a *Pi* filter made up of inductors and capacitors—all designed to essentially low-pass filter the 5V supply, removing the high-frequency noise.

**PACKAGING INFORMATION**

Orderable Device	Status <sup>(1)</sup>	Package Type	Package Drawing	Pins	Package Qty	Eco Plan <sup>(2)</sup>	Lead/Ball Finish	MSL Peak Temp <sup>(3)</sup>
DAC8551IADGKR	ACTIVE	MSOP	DGK	8	2500	Green (RoHS & no Sb/Br)	CU NIPDAU	Level-1-260C-UNLIM
DAC8551IADGKRG4	ACTIVE	MSOP	DGK	8	2500	Green (RoHS & no Sb/Br)	CU NIPDAU	Level-1-260C-UNLIM
DAC8551IADGKT	ACTIVE	MSOP	DGK	8	250	Green (RoHS & no Sb/Br)	CU NIPDAU	Level-1-260C-UNLIM
DAC8551IADGKTG4	ACTIVE	MSOP	DGK	8	250	Green (RoHS & no Sb/Br)	CU NIPDAU	Level-1-260C-UNLIM
DAC8551IDGKR	ACTIVE	MSOP	DGK	8	2500	Green (RoHS & no Sb/Br)	CU NIPDAU	Level-1-260C-UNLIM
DAC8551IDGKRG4	ACTIVE	MSOP	DGK	8	2500	Green (RoHS & no Sb/Br)	CU NIPDAU	Level-1-260C-UNLIM
DAC8551IDGKT	ACTIVE	MSOP	DGK	8	250	Green (RoHS & no Sb/Br)	CU NIPDAU	Level-1-260C-UNLIM
DAC8551IDGKTG4	ACTIVE	MSOP	DGK	8	250	Green (RoHS & no Sb/Br)	CU NIPDAU	Level-1-260C-UNLIM

<sup>(1)</sup> The marketing status values are defined as follows:

**ACTIVE:** Product device recommended for new designs.

**LIFEBUY:** TI has announced that the device will be discontinued, and a lifetime-buy period is in effect.

**NRND:** Not recommended for new designs. Device is in production to support existing customers, but TI does not recommend using this part in a new design.

**PREVIEW:** Device has been announced but is not in production. Samples may or may not be available.

**OBSOLETE:** TI has discontinued the production of the device.

<sup>(2)</sup> Eco Plan - The planned eco-friendly classification: Pb-Free (RoHS), Pb-Free (RoHS Exempt), or Green (RoHS & no Sb/Br) - please check <http://www.ti.com/productcontent> for the latest availability information and additional product content details.

**TBD:** The Pb-Free/Green conversion plan has not been defined.

**Pb-Free (RoHS):** TI's terms "Lead-Free" or "Pb-Free" mean semiconductor products that are compatible with the current RoHS requirements for all 6 substances, including the requirement that lead not exceed 0.1% by weight in homogeneous materials. Where designed to be soldered at high temperatures, TI Pb-Free products are suitable for use in specified lead-free processes.

**Pb-Free (RoHS Exempt):** This component has a RoHS exemption for either 1) lead-based flip-chip solder bumps used between the die and package, or 2) lead-based die adhesive used between the die and leadframe. The component is otherwise considered Pb-Free (RoHS compatible) as defined above.

**Green (RoHS & no Sb/Br):** TI defines "Green" to mean Pb-Free (RoHS compatible), and free of Bromine (Br) and Antimony (Sb) based flame retardants (Br or Sb do not exceed 0.1% by weight in homogeneous material)

<sup>(3)</sup> MSL, Peak Temp. -- The Moisture Sensitivity Level rating according to the JEDEC industry standard classifications, and peak solder temperature.

**Important Information and Disclaimer:**The information provided on this page represents TI's knowledge and belief as of the date that it is provided. TI bases its knowledge and belief on information provided by third parties, and makes no representation or warranty as to the accuracy of such information. Efforts are underway to better integrate information from third parties. TI has taken and continues to take reasonable steps to provide representative and accurate information but may not have conducted destructive testing or chemical analysis on incoming materials and chemicals. TI and TI suppliers consider certain information to be proprietary, and thus CAS numbers and other limited information may not be available for release.

In no event shall TI's liability arising out of such information exceed the total purchase price of the TI part(s) at issue in this document sold by TI to Customer on an annual basis.

**TAPE AND REEL INFORMATION**



**QUADRANT ASSIGNMENTS FOR PIN 1 ORIENTATION IN TAPE**



\*All dimensions are nominal

Device	Package Type	Package Drawing	Pins	SPQ	Reel Diameter (mm)	Reel Width W1 (mm)	A0 (mm)	B0 (mm)	K0 (mm)	P1 (mm)	W (mm)	Pin1 Quadrant
DAC8551IADGKR	MSOP	DGK	8	2500	330.0	12.4	5.3	3.4	1.4	8.0	12.0	Q1
DAC8551IADGKT	MSOP	DGK	8	250	330.0	12.4	5.3	3.4	1.4	8.0	12.0	Q1
DAC8551IDGKR	MSOP	DGK	8	2500	330.0	12.4	5.3	3.4	1.4	8.0	12.0	Q1
DAC8551IDGKT	MSOP	DGK	8	250	330.0	12.4	5.3	3.4	1.4	8.0	12.0	Q1

**TAPE AND REEL BOX DIMENSIONS**



\*All dimensions are nominal

Device	Package Type	Package Drawing	Pins	SPQ	Length (mm)	Width (mm)	Height (mm)
DAC8551IADGKR	MSOP	DGK	8	2500	346.0	346.0	29.0
DAC8551IADGKT	MSOP	DGK	8	250	346.0	346.0	29.0
DAC8551IDGKR	MSOP	DGK	8	2500	346.0	346.0	29.0
DAC8551IDGKT	MSOP	DGK	8	250	346.0	346.0	29.0

DGK (S-PDSO-G8)

PLASTIC SMALL-OUTLINE PACKAGE



- NOTES:
- A. All linear dimensions are in millimeters.
  - B. This drawing is subject to change without notice.
  - C. Body length does not include mold flash, protrusions, or gate burrs. Mold flash, protrusions, or gate burrs shall not exceed 0.15 per end.
  - D. Body width does not include interlead flash. Interlead flash shall not exceed 0.50 per side.
  - E. Falls within JEDEC MO-187 variation AA, except interlead flash.



## IMPORTANT NOTICE

Texas Instruments Incorporated and its subsidiaries (TI) reserve the right to make corrections, modifications, enhancements, improvements, and other changes to its products and services at any time and to discontinue any product or service without notice. Customers should obtain the latest relevant information before placing orders and should verify that such information is current and complete. All products are sold subject to TI's terms and conditions of sale supplied at the time of order acknowledgment.

TI warrants performance of its hardware products to the specifications applicable at the time of sale in accordance with TI's standard warranty. Testing and other quality control techniques are used to the extent TI deems necessary to support this warranty. Except where mandated by government requirements, testing of all parameters of each product is not necessarily performed.

TI assumes no liability for applications assistance or customer product design. Customers are responsible for their products and applications using TI components. To minimize the risks associated with customer products and applications, customers should provide adequate design and operating safeguards.

TI does not warrant or represent that any license, either express or implied, is granted under any TI patent right, copyright, mask work right, or other TI intellectual property right relating to any combination, machine, or process in which TI products or services are used. Information published by TI regarding third-party products or services does not constitute a license from TI to use such products or services or a warranty or endorsement thereof. Use of such information may require a license from a third party under the patents or other intellectual property of the third party, or a license from TI under the patents or other intellectual property of TI.

Reproduction of TI information in TI data books or data sheets is permissible only if reproduction is without alteration and is accompanied by all associated warranties, conditions, limitations, and notices. Reproduction of this information with alteration is an unfair and deceptive business practice. TI is not responsible or liable for such altered documentation. Information of third parties may be subject to additional restrictions.

Resale of TI products or services with statements different from or beyond the parameters stated by TI for that product or service voids all express and any implied warranties for the associated TI product or service and is an unfair and deceptive business practice. TI is not responsible or liable for any such statements.

TI products are not authorized for use in safety-critical applications (such as life support) where a failure of the TI product would reasonably be expected to cause severe personal injury or death, unless officers of the parties have executed an agreement specifically governing such use. Buyers represent that they have all necessary expertise in the safety and regulatory ramifications of their applications, and acknowledge and agree that they are solely responsible for all legal, regulatory and safety-related requirements concerning their products and any use of TI products in such safety-critical applications, notwithstanding any applications-related information or support that may be provided by TI. Further, Buyers must fully indemnify TI and its representatives against any damages arising out of the use of TI products in such safety-critical applications.

TI products are neither designed nor intended for use in military/aerospace applications or environments unless the TI products are specifically designated by TI as military-grade or "enhanced plastic." Only products designated by TI as military-grade meet military specifications. Buyers acknowledge and agree that any such use of TI products which TI has not designated as military-grade is solely at the Buyer's risk, and that they are solely responsible for compliance with all legal and regulatory requirements in connection with such use.

TI products are neither designed nor intended for use in automotive applications or environments unless the specific TI products are designated by TI as compliant with ISO/TS 16949 requirements. Buyers acknowledge and agree that, if they use any non-designated products in automotive applications, TI will not be responsible for any failure to meet such requirements.

Following are URLs where you can obtain information on other Texas Instruments products and application solutions:

### Products

Amplifiers	<a href="http://amplifier.ti.com">amplifier.ti.com</a>
Data Converters	<a href="http://dataconverter.ti.com">dataconverter.ti.com</a>
DSP	<a href="http://dsp.ti.com">dsp.ti.com</a>
Clocks and Timers	<a href="http://www.ti.com/clocks">www.ti.com/clocks</a>
Interface	<a href="http://interface.ti.com">interface.ti.com</a>
Logic	<a href="http://logic.ti.com">logic.ti.com</a>
Power Mgmt	<a href="http://power.ti.com">power.ti.com</a>
Microcontrollers	<a href="http://microcontroller.ti.com">microcontroller.ti.com</a>
RFID	<a href="http://www.ti-rfid.com">www.ti-rfid.com</a>
RF/IF and ZigBee® Solutions	<a href="http://www.ti.com/lprf">www.ti.com/lprf</a>

### Applications

Audio	<a href="http://www.ti.com/audio">www.ti.com/audio</a>
Automotive	<a href="http://www.ti.com/automotive">www.ti.com/automotive</a>
Broadband	<a href="http://www.ti.com/broadband">www.ti.com/broadband</a>
Digital Control	<a href="http://www.ti.com/digitalcontrol">www.ti.com/digitalcontrol</a>
Medical	<a href="http://www.ti.com/medical">www.ti.com/medical</a>
Military	<a href="http://www.ti.com/military">www.ti.com/military</a>
Optical Networking	<a href="http://www.ti.com/opticalnetwork">www.ti.com/opticalnetwork</a>
Security	<a href="http://www.ti.com/security">www.ti.com/security</a>
Telephony	<a href="http://www.ti.com/telephony">www.ti.com/telephony</a>
Video & Imaging	<a href="http://www.ti.com/video">www.ti.com/video</a>
Wireless	<a href="http://www.ti.com/wireless">www.ti.com/wireless</a>

Mailing Address: Texas Instruments, Post Office Box 655303, Dallas, Texas 75265  
Copyright © 2008, Texas Instruments Incorporated